

AXOR Starck

Overhead shower 240 1jet

Surfaces: Article Number: **28494820**



product features

- shower head size: 240 mm
- spray type: RainAir
- ball-joint: overhead shower angle adjustable
- material spray disc: metal
- maximum flow rate at 3 bar: 19 l/min
- flow rate RainAir spray (at 3 bar): 19 l/min
- minimum flow pressure: 1,5 bar
- spray disc removable for cleaning
- installation: ceiling or wall
- connection thread G ½
- connection dimension: DN15
- suitable for continuous flow water heaters

Technology



Product image



Scale drawing

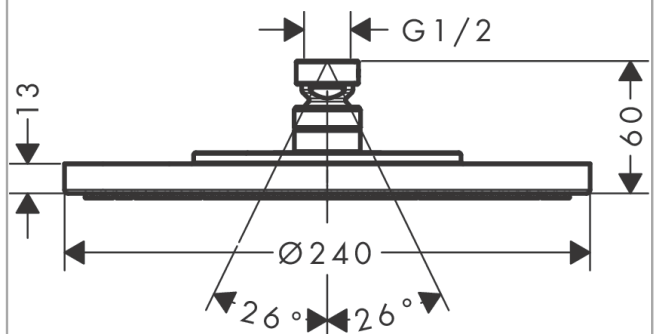

AXOR Starck
Overhead shower 240 1jet
Surfaces: Article Number: **28494820**



Flowchart

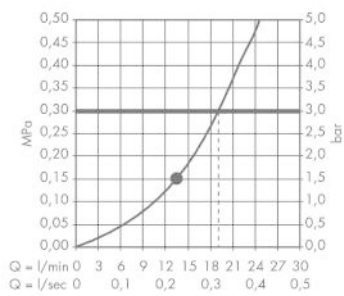

The consumption was measured in combination with the appropriate fittings (thermosta/mixer/
in-wall valve) to reflect actual application in practice.

AXOR Starck
Overhead shower 240 1jet
Surfaces: Article Number: **28494820**



Exploded Drawing

Year of production: >11/16

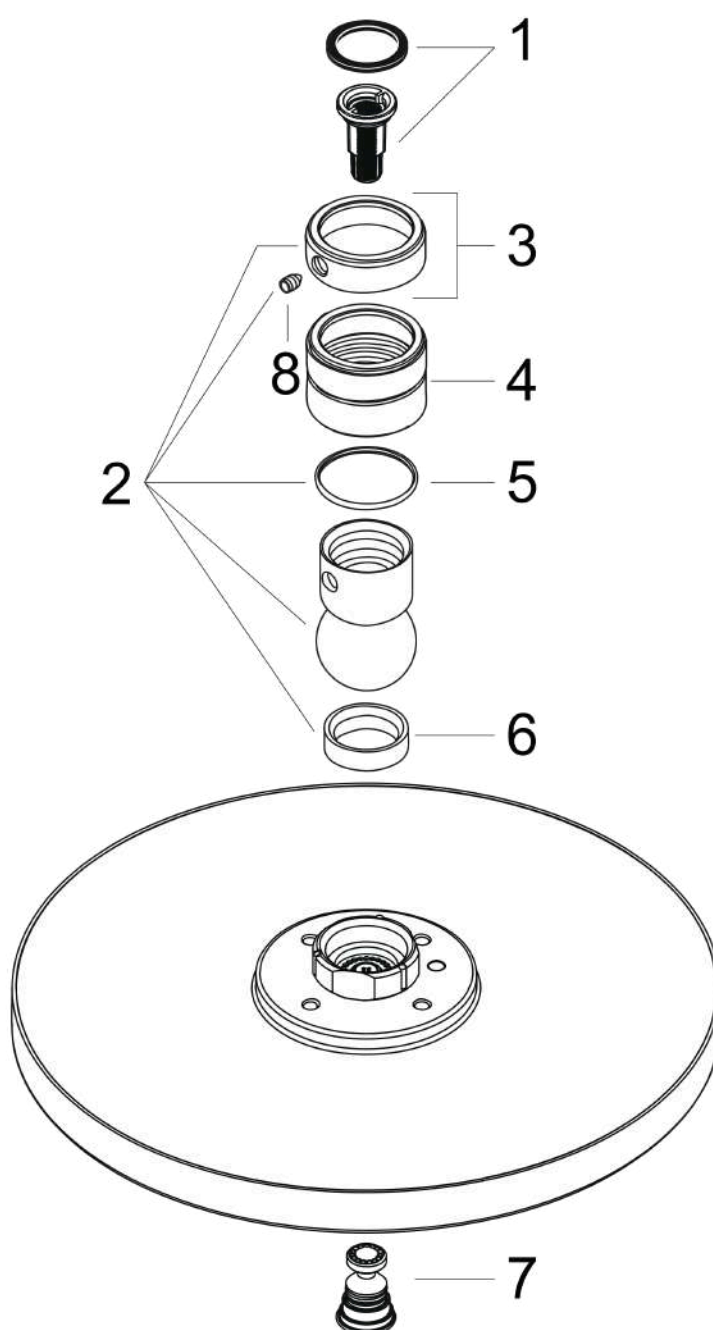

AXOR Starck
Overhead shower 240 1jet
 Surfaces: Article Number: **28494820**



Spare part list

Year of production: >11/16

Pos.		Article Number	PC	PU
1	filter insert	97708000	2	1
2	ball joint	98941820	11	1
3	lock washer	98942820	8	1
4	nut	97958820	3	1
5	lever collar	97536000	2	1
6	seal	97606000	2	1
7	air jet	95794820	10	1
8	hollow set screw M4x6	97767000	1	1
a	non return valve	95699000	5	1