

AXOR Starck Organic
Single lever shower mixer for concealed installation
 Surfaces: Article Number: **12605800**



product features

- 1 function
- maximum flow rate at 3 bar: 29,3 l/min
- ceramic cartridge
- temperature limitation adjustable
- with silencer
- suitable for continuous flow water heaters
- connection type: basic set
- min. operating pressure: 1 bar
- max. operating pressure: 10 bar

Product image



Scale drawing

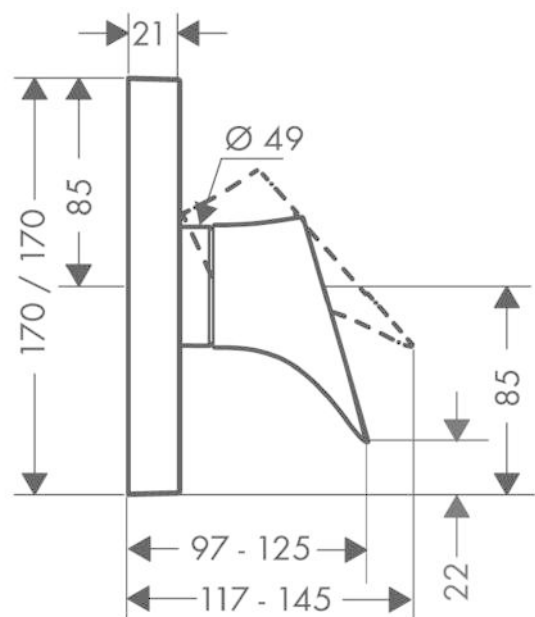

AXOR Starck Organic
Single lever shower mixer for concealed installation
Surfaces: Article Number: **12605800**



Flowchart

