

**AXOR Starck Organic**  
**Single lever shower mixer for concealed installation**  
 Surfaces: Article Number: **12605310**



**product features**

- 1 function
- maximum flow rate at 3 bar: 29,3 l/min
- ceramic cartridge
- temperature limitation adjustable
- with silencer
- suitable for continuous flow water heaters
- connection type: basic set
- min. operating pressure: 1 bar
- max. operating pressure: 10 bar

**Product image**



**Scale drawing**

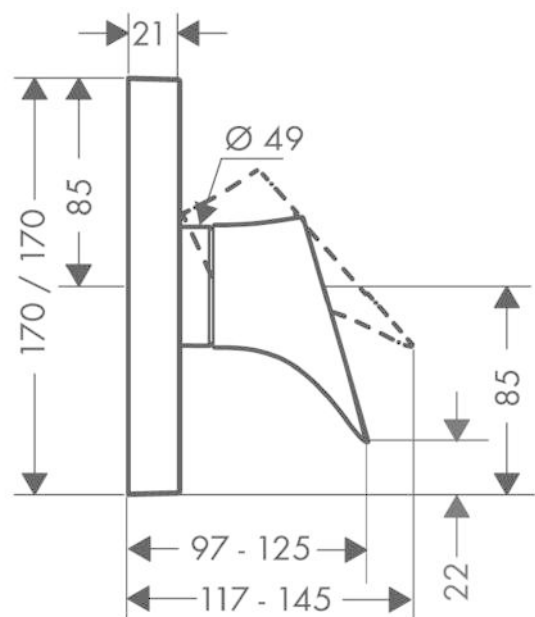

**AXOR Starck Organic**  
**Single lever shower mixer for concealed installation**  
Surfaces: Article Number: **12605310**



## Flowchart

