

AXOR Starck Organic
Shower thermostat for exposed installation
 Surfaces: Article Number: **12602330**



product features

- 1 function
- thermostat cartridge
- maximum flow rate at 3 bar: 17 l/min
- min. operating pressure: 1 bar
- max. operating pressure: 10 bar
- safety stop at 40 °C
- temperature limitation adjustable
- non-return valve
- with silencer
- connection type: s-shaped connections
- centre distance: 150 ± 12 mm
- connection dimension: DN15

Product image



Scale drawing

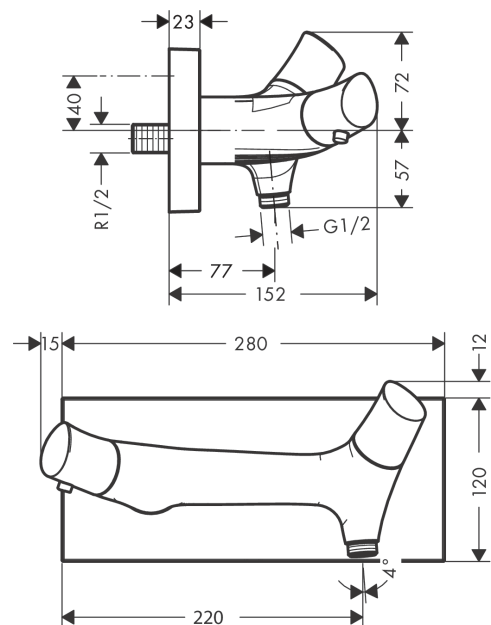

AXOR Starck Organic
Shower thermostat for exposed installation
Surfaces: Article Number: **12602330**



Flowchart

