

**AXOR Starck Organic**  
**Bath thermostat for exposed installation**  
 Surfaces: Article Number: **12410340**



**product features**

- projection 218 mm
- 2 functions
- spray type mixer: laminar spray
- maximum flow rate at 3 bar: 21 l/min
- flow rate for bath spout at 3 bar: 21 l/min
- flow rate of hand shower at 3 bar: 18 l/min
- min. operating pressure: 1 bar
- max. operating pressure: 10 bar
- thermostat cartridge, shut-off/ diverter valve
- safety stop at 40 °C
- temperature limitation adjustable
- non-return valve
- with silencer
- connection type: s-shaped connections
- connection dimension: DN15
- centre distance: 150 ± 12 mm

**Product image**



**Scale drawing**

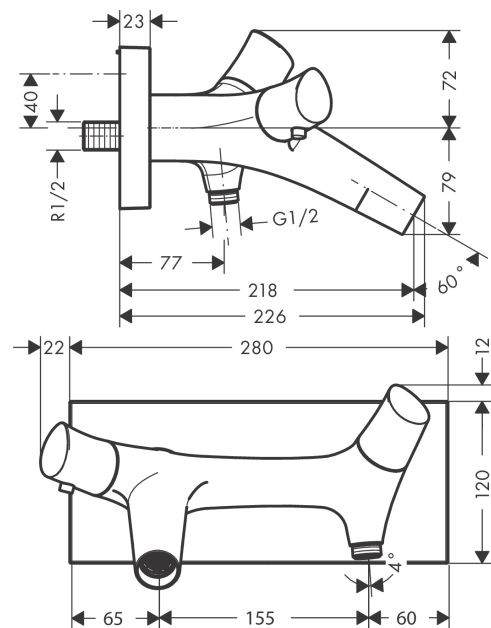

**AXOR Starck Organic**  
**Bath thermostat for exposed installation**  
 Surfaces: Article Number: **12410340**



## Flowchart

