

AXOR Starck V

Single lever basin mixer 140 with glass spout and waste set

Surfaces: Article Number: **12112990**



product features

- consists of: single lever basin mixer, waste set
- ComfortZone 140
- projection: 125 mm
- spout height: 141 mm
- swivel range adjustable in 3 steps 95°, 120° or 360°
- spray type: laminar spray
- EasyClick connection between body and spout with SafetyStop-function
- Spout is dishwasher safe
- material spout: crystal glass
- maximum flow rate at 3 bar: 4 l/min
- ceramic cartridge
- non-closing waste set
- connection type: G 3/8 connections
- connection dimension: DN15
- handle can be positioned on the right or left
- handle position on the side: bottom-side at the base body (not suitable for wash bowls)
- not recommended for the public and semi-public area

Technology



AXOR Starck V
Single lever basin mixer 140 with glass spout and waste set
 Surfaces: Article Number: **12112990**



Product image



Scale drawing

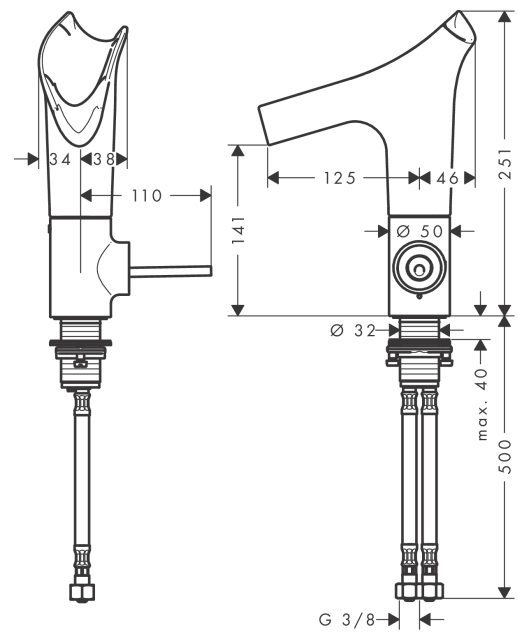

Flowchart

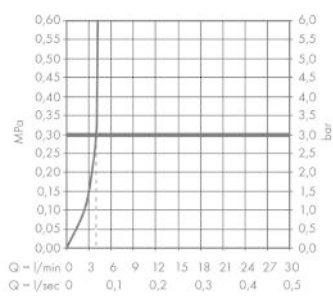

AXOR Starck V
Single lever basin mixer 140 with glass spout and waste set
 Surfaces: Article Number: **12112990**



Exploded Drawing

Year of production: >11/16

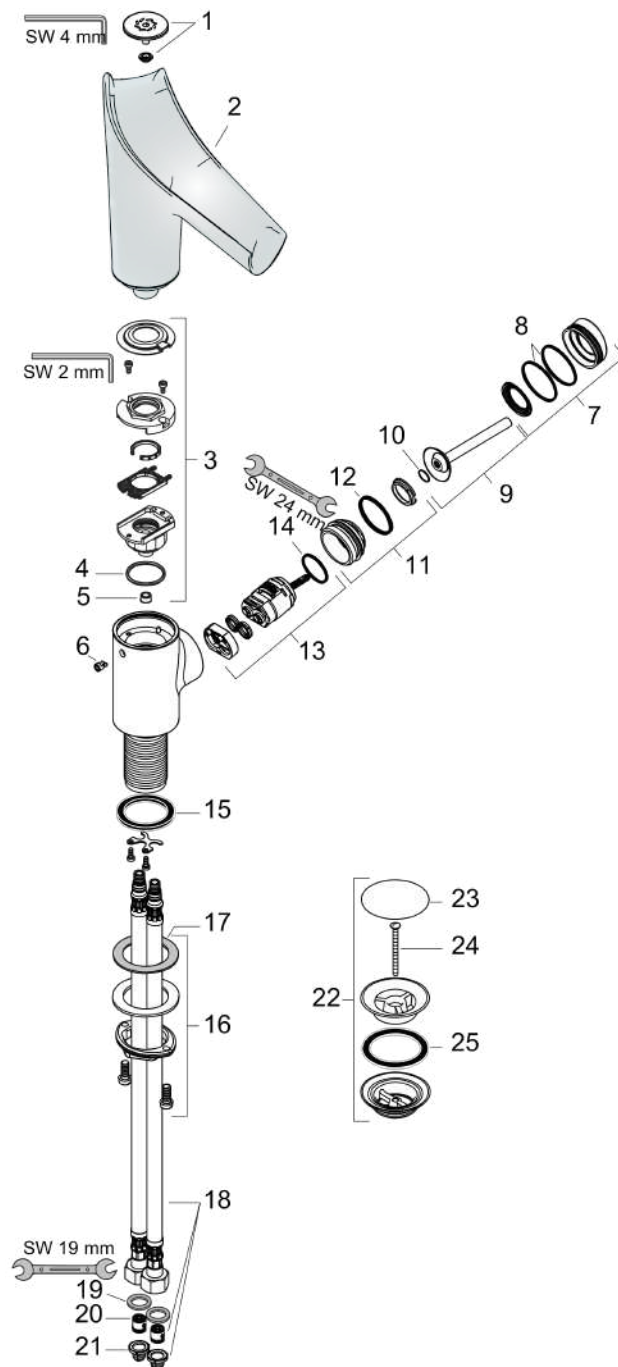

AXOR Starck V
Single lever basin mixer 140 with glass spout and waste set
 Surfaces: Article Number: **12112990**



Spare part list

Year of production: >11/16

Pos.		Article Number	PC	PU
1	spray head cpl.	92486990	16	1
2	spout cpl.	92487000	21	1
3	service unit	92488000	16	1
4	O-ring 26x2	98147000	1	1
5	flow limiter (4 l/min)	92491000	4	1
6	pushbutton	92492990	11	1
7	escutcheon	92489990	16	1
8	O-ring 35x1,5	92114000	2	1
9	handle	92490990	16	1
10	O-ring 9x2	98119000	1	1
11	nut	95667000	7	1
12	O-ring 30x1,5	98433000	1	1
13	cartridge, assy	96339000	12	1
14	O-ring 21,95x1,78	95169000	1	1
15	flat seal	98749000	2	1
16	fixing set (Ø 32)	13961000	7	1
17	lever collar	97548000	1	1
18	connection hose 450 mm M8x0,75 G3/8	98809000	10	1
19	sealing set	95581000	2	1
20	non return valve DW 10	96456000	3	1
21	filter packing	95291000	4	1
22	waste	50001990	99	1
23	cover	97141990	8	1
24	screw	98000000	2	1
25	form ring	96361000	3	1
a	fixation extension 35 mm	13898000	12	1
b	spray body (recommended at operating pressure < 0,15 MPa)	92341000	14	1