

AXOR Starck Organic
Pillar tap 50 without waste set
 Surfaces: Article Number: **12110820**



product features

- ComfortZone 50
- projection: 109 mm
- spout height: 50 mm
- spray type: shower spray
- maximum flow rate at 3 bar: 3,5 l/min
- flow rate booster: 5 l/min
- ceramic valve for volume control
- with isolated water conduction - without contact with nickel and lead
- suitable for continuous flow water heaters
- for cold water connection
- connection type: G 3/8 connection hose
- connection dimension: DN15

Technology



Product image



Scale drawing

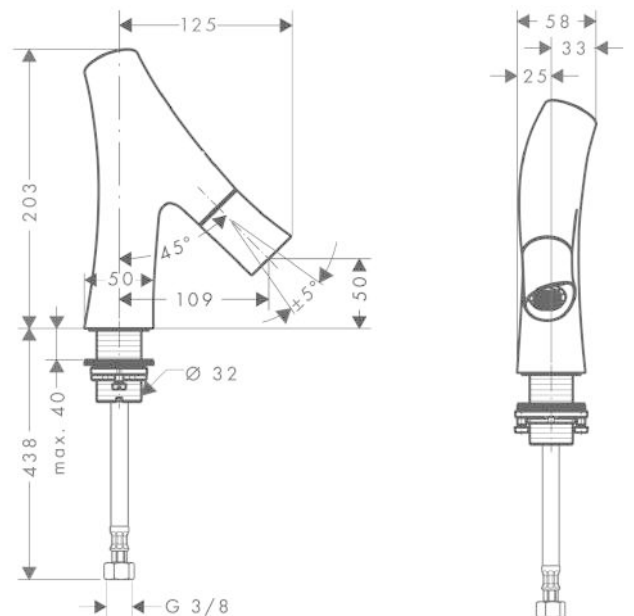

AXOR Starck Organic
Pillar tap 50 without waste set
 Surfaces: Article Number: **12110820**



Flowchart

