

AXOR Starck Organic
2-handle basin mixer for concealed installation wall-mounted with spout 187 mm
 Surfaces: Article Number: **12015250**



product features

- consists of: 2-handle basin mixer, waste set
- projection: 187 mm
- spray type: shower spray
- maximum flow rate at 3 bar: 3,5 l/min
- flow rate booster: 5 l/min
- ceramic cartridge for temperature control
- ceramic valve for volume control
- temperature limitation adjustable
- separation of temperature and volume control
- with isolated water conduction - without contact with nickel and lead
- suitable for continuous flow water heaters
- non-closing waste set
- connection type: basic set
- connection dimension: DN15

Technology



Product image



Scale drawing

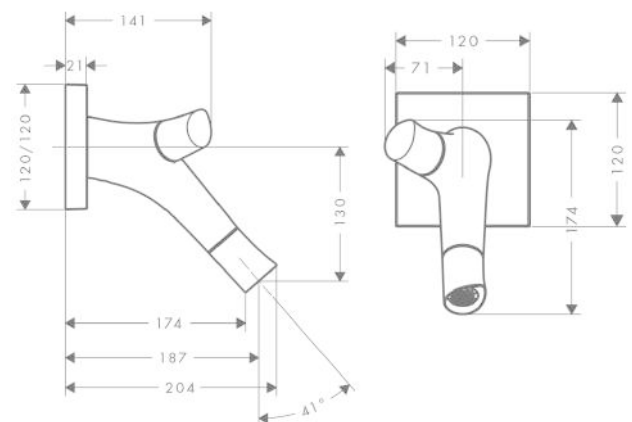

AXOR Starck Organic
2-handle basin mixer for concealed installation wall-mounted with spout 187 mm
 Surfaces: Article Number: **12015250**



Flowchart

