

AXOR Starck Organic
2-handle basin mixer 80 with pop-up waste set
 Surfaces: Article Number: **12010250**



product features

- consists of: 2-handle basin mixer, waste set
- ComfortZone 80
- projection: 116 mm
- spout height: 83 mm
- spray type: shower spray
- maximum flow rate at 3 bar: 3,5 l/min
- flow rate booster: 5 l/min
- ceramic cartridge for temperature control
- ceramic valve for volume control
- temperature limitation adjustable
- separation of temperature and volume control
- with isolated water conduction - without contact with nickel and lead
- suitable for continuous flow water heaters
- pop-up waste set G 1¼
- connection type: G ¾ connections
- connection dimension: DN15

Technology



Product image



Scale drawing

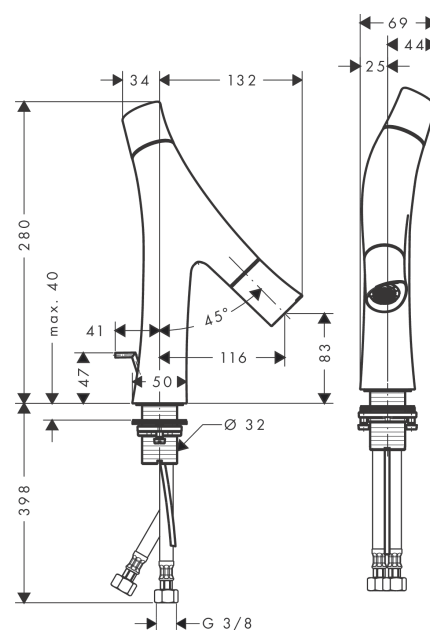

AXOR Starck Organic
2-handle basin mixer 80 with pop-up waste set
 Surfaces: Article Number: **12010250**



Flowchart

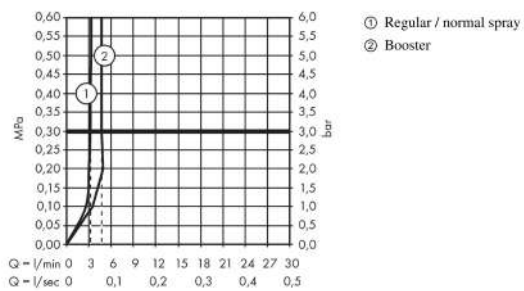

AXOR Starck Organic
2-handle basin mixer 80 with pop-up waste set
 Surfaces: Article Number: 12010250



Exploded Drawing

Year of production: >11/16

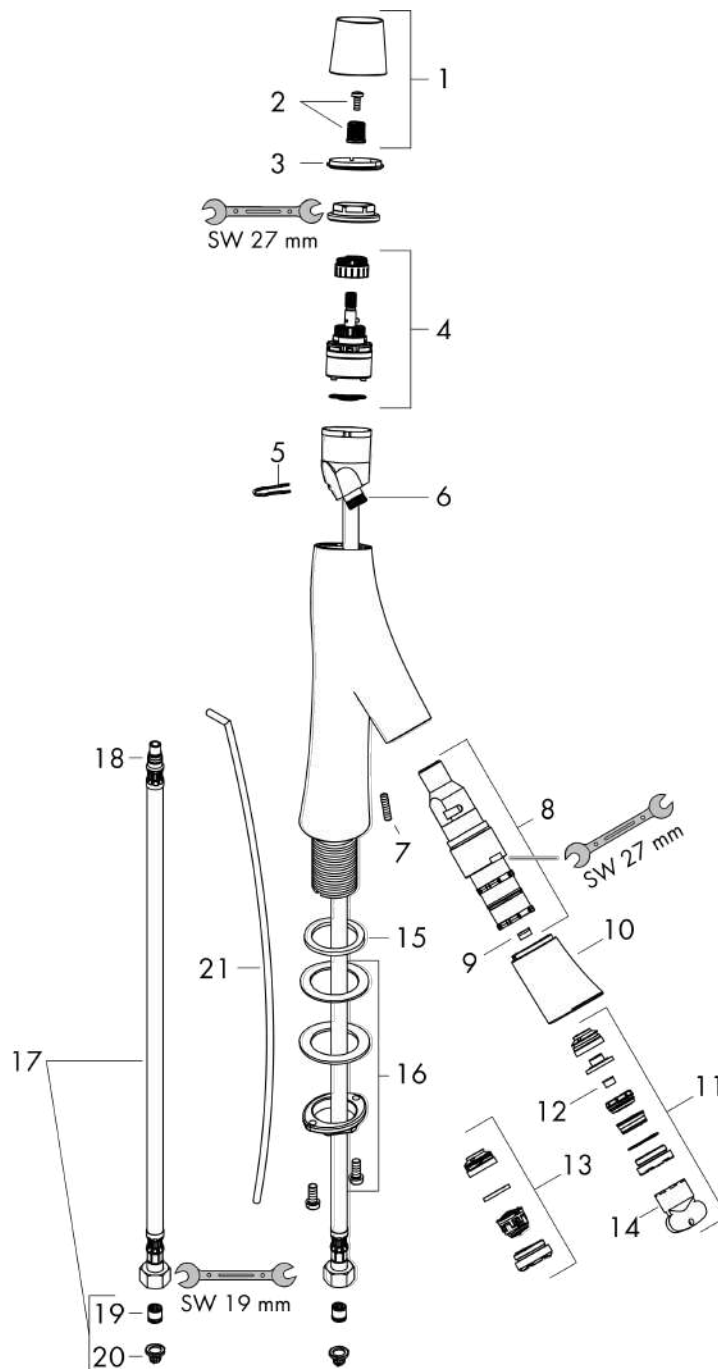

AXOR Starck Organic
2-handle basin mixer 80 with pop-up waste set
 Surfaces: Article Number: **12010250**



Spare part list

Year of production: >11/16

Pos.		Article Number	PC	PU
1	handle	98296250	99	1
2	handle fixing set	98932000	5	1
3	color-ring cold / hot water	98304000	3	1
4	cartridge, assy	98303000	12	1
5	cramp	98403000	3	1
6	O-ring 11x1,5	98385000	1	1
7	hollow set screw M5x16	98404000	1	1
8	shut off cartridge	98301000	16	1
9	flow limiter (3,5 l/min)	98405000	3	1
10	spout cpl.	98297250	64	1
11	spray former	98299990	64	1
12	flow limiter (5 l/min)	95311000	2	1
13	aerator M24x1 (7 l/min)	98300990	60	1
14	special tool	95158000	2	1
15	flat seal	98749000	2	1
16	fixing set (Ø 32)	13961000	7	1
17	pull rod	96923250	99	1
18	connection hose 600 mm M8x0,75 G3/8	95664000	8	1
19	O-ring 7x1,5	98422000	1	1
20	non return valve DW 10	96456000	3	1
21	filter packing	95291000	4	1
a	pop up waste	94139250	99	1
b	fixation extension 35 mm	13898000	12	1