

AXOR Starck

Thermostat for concealed installation with shut-off/ diverter valve

Surfaces: Article Number: **10720800**



product features

- 2 functions
- thermostat cartridge, shut-off valve
- maximum flow rate at 3 bar: 29 l/min
- flow rate upper outlet: 25 l/min
- flow rate lower outlet: 29 l/min
- min. operating pressure: 1 bar
- max. operating pressure: 10 bar
- safety stop at 40 °C
- temperature limitation adjustable
- non-return valve
- with silencer
- connection type: basic set

Certificates



Product image



Scale drawing

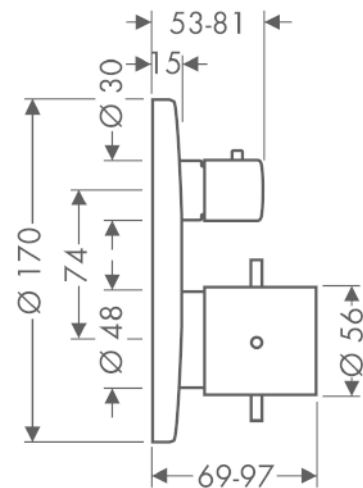

AXOR Starck

Thermostat for concealed installation with shut-off/ diverter valve

Surfaces: Article Number: **10720800**



Flowchart

