

AXOR Starck
Thermostat for concealed installation with shut-off valve
 Surfaces: Article Number: **10700340**



product features

- 1 function
- thermostat cartridge, ceramic valves 90°
- maximum flow rate at 3 bar: 25 l/min
- min. operating pressure: 1 bar
- max. operating pressure: 10 bar
- safety lock at 40 °C
- temperature limitation adjustable
- non-return valve
- with silencer
- connection type: basic set

Product image



Scale drawing

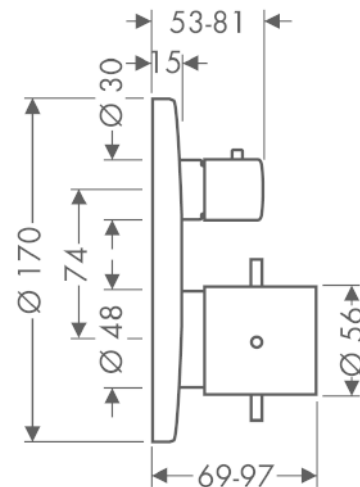

AXOR Starck
Thermostat for concealed installation with shut-off valve
Surfaces: Article Number: **10700340**



Flowchart

