

AXOR Starck

Single lever manual bath mixer for exposed installation with pin handle

Surfaces: Art. no. : **10411950**



product features

- designed to run 2 outlets
- spout 200 mm long
- Centre distance: 150 mm ± 16 mm
- Spray type mixer: normal spray
- Maximum flow rate (at 3 bar): 18 l/min
- Flow rate for bath spout (at 3 bar): 18 l/min
- Flow rate of hand shower (at 3 bar): 16 l/min
- ceramic cartridge
- Maximum temperature can be adjusted on installation
- diverter with automatic resetting
- Non-return valve
- with silencer
- exposed installation
- Noise class: II
- Connection type: S connections
- Min. operating pressure: 1 bar
- Max. operating pressure: 10 bar
- non thermostatic
- winner of the iF product design award 2005
- WRAS 2012021
- WRAS 2012021 - Approval letter

Article Details

Price excl. VAT £ 1,096.70

Technology



Certificates



AXOR Starck

Single lever manual bath mixer for exposed installation with pin handle

Surfaces: Art. no. : 10411950



Product image



Scale drawing

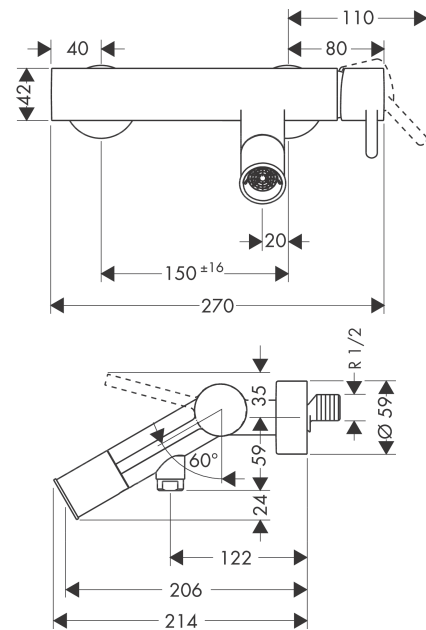

Flowchart

