

**AXOR Starck**  
**Single lever basin mixer 80 with pop-up waste**  
 Surfaces: Art. no. : **10102990**



### product features

- Consists of: single lever basin mixer, waste set
- ComfortZone 80 provides space for greater freedom of movement
- spout 86 mm long
- spout height: 75 mm
- free-standing installation
- Spray pattern: normal spray
- Maximum flow rate (at 3 bar): 5 l/min
- Min. operating pressure: 1 bar
- Max. operating pressure: 10 bar
- ceramic cartridge
- pop-up waste set 1 1/4"
- QuickClean technology for easy limescale removal
- operating pressure: min. 1 bar / max. 6 bar
- WRAS 2101002
- WRAS 2101002 - Approval letter

### Article Details

Price excl. VAT £ 401.30

### Technology



### Certificates



### Product image



### Scale drawing

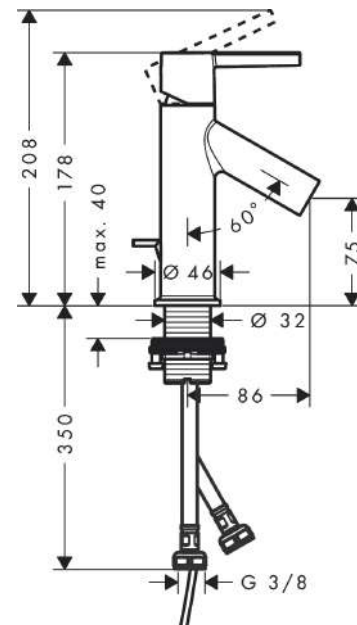

**AXOR Starck**  
**Single lever basin mixer 80 with pop-up waste**  
Surfaces: Art. no. : **10102990**



## Flowchart

