

AXOR Starck
2-handle basin mixer 80 with pop-up waste
 Surfaces: Art. no. : **10030990**



product features

- Consists of: 2-handle basin mixer, waste set
- ComfortZone 80 provides space for greater freedom of movement
- spout 105 mm long
- spout height: 75 mm
- free-standing installation
- Spray pattern: normal spray
- Maximum flow rate (at 3 bar): 5 l/min
- Min. operating pressure: 1 bar
- Max. operating pressure: 10 bar
- ceramic valves hot / cold 180°
- pop-up waste set 1¼"
- QuickClean technology for easy limescale removal
- please specify when ordering if required for low pressure
- winner of the iF product design award 1994

Article Details

Price excl. VAT

£ 876.10

Technology



Product image



Scale drawing

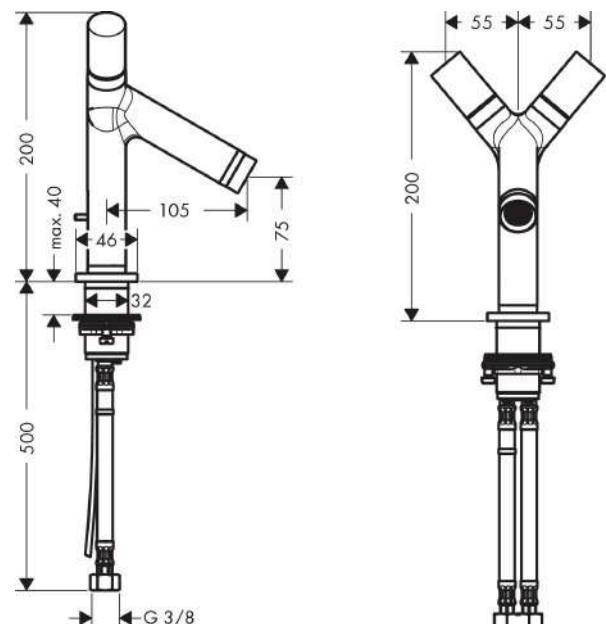

AXOR Starck
2-handle basin mixer 80 with pop-up waste
 Surfaces: Art. no. : **10030990**



Flowchart

