

## AXOR Starck

### Single lever basin mixer 100 with lever handle and pop-up waste

Surfaces: Art. no. : 10001800



#### product features

- Consists of: single lever basin mixer, waste set
- ComfortZone 100 provides space for greater freedom of movement
- spout 103 mm long
- spout height: 95 mm
- free-standing installation
- Spray pattern: normal spray
- Maximum flow rate (at 3 bar): 5 l/min
- Min. operating pressure: 1 bar
- Max. operating pressure: 10 bar
- ceramic cartridge
- pop-up waste set 1 1/4"
- QuickClean technology for easy limescale removal
- operating pressure: min. 1 bar / max. 6 bar
- WRAS 2101002
- WRAS 2101002 - Approval letter

#### Article Details

Price excl. VAT

£ 401.30

#### Technology



#### Certificates



#### Product image



#### Scale drawing

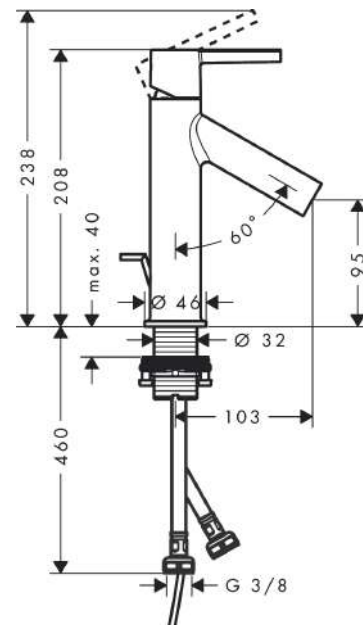

**AXOR Starck**  
**Single lever basin mixer 100 with lever handle and pop-up waste**  
Surfaces: Art. no. : **10001800**



## Flowchart

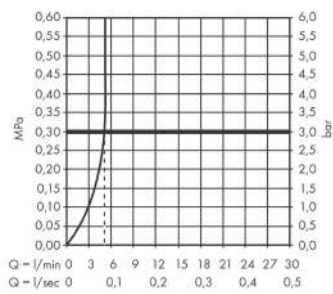

**AXOR Starck**  
**Single lever basin mixer 100 with lever handle and pop-up waste**  
 Surfaces: Art. no. : 10001800



## Exploded Drawing

Year of production: >02/19

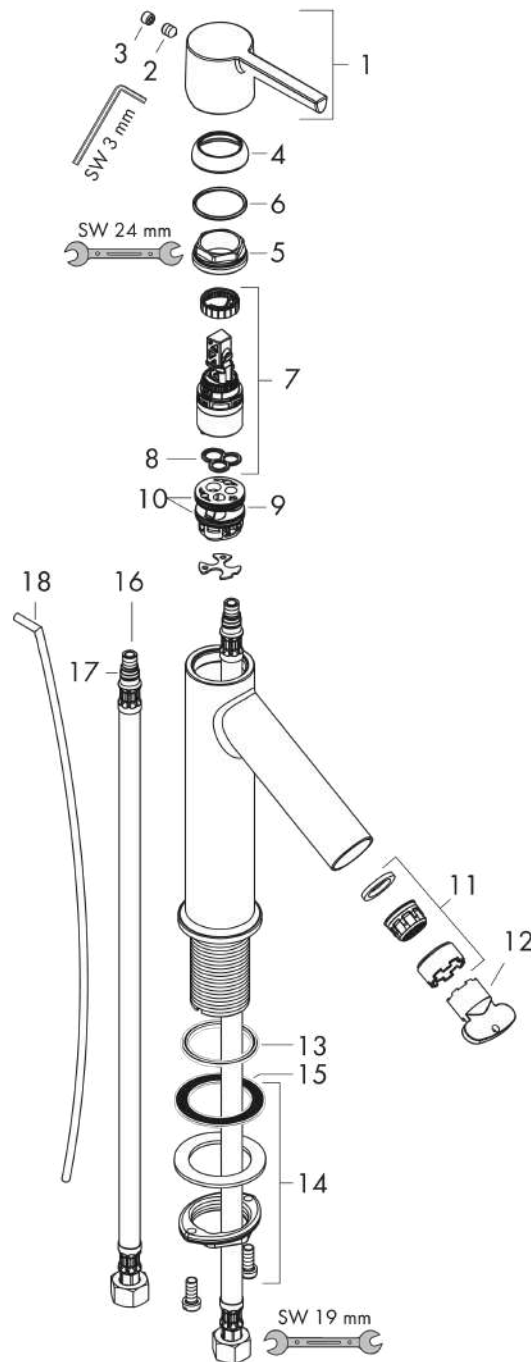

**AXOR Starck**  
**Single lever basin mixer 100 with lever handle and pop-up waste**  
 Surfaces: Art. no. : **10001800**



## Spare part list

Year of production: >02/19

Pos.		Art. no.	Price	PU
1	handle	92385800	-	1
2	hollow set screw M6x8	98444000	-	1
3	screw cover	96762000	-	1
4	flange	98863800	-	1
5	nut	95178000	-	1
6	O-ring 24x2	98388000	-	1
7	cartridge, assy	97685000	-	1
8	seal	98865000	-	1
9	adapter for cartridge	98866000	-	1
10	O-ring 23x2	98398000	-	1
11	aerator M24x1 (5 l/min)	92386800	-	1
12	special tool	95290000	-	1
13	O-ring 34x4	98155000	-	1
14	fixing set (Ø 32)	13961000	-	1
15	lever collar	97548000	-	1
16	connection hose 600 mm M8x0,75 G3/8	96510000	-	1
17	O-ring 7x1,5	98422000	-	1
18	pull rod	97158800	-	1
a	pop up waste	94139800	-	1
b	fixation extension 35 mm	13898000	-	1